

8 7 6 5 4 3 2 1

D

D

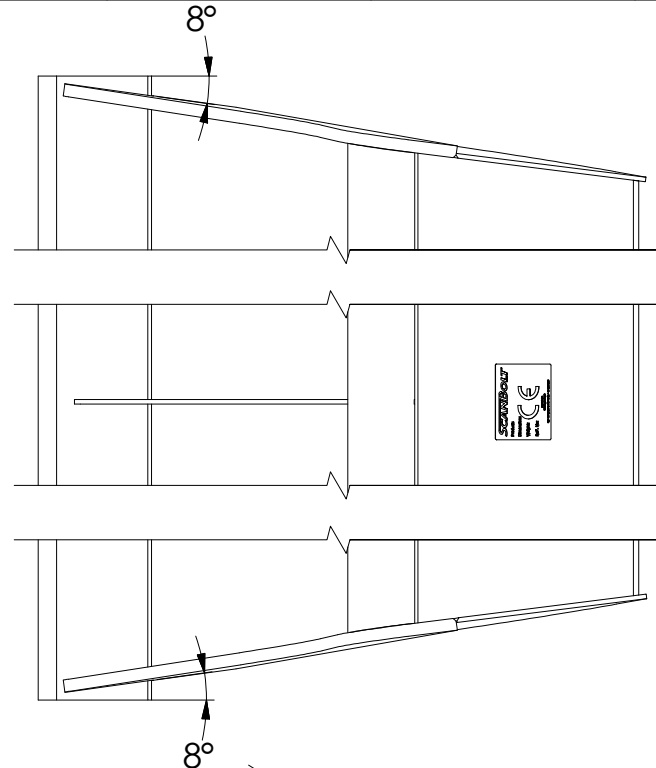

C

C



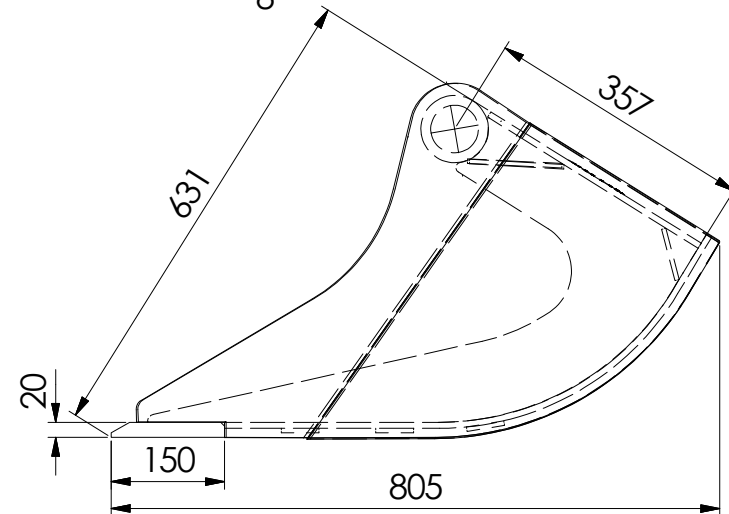
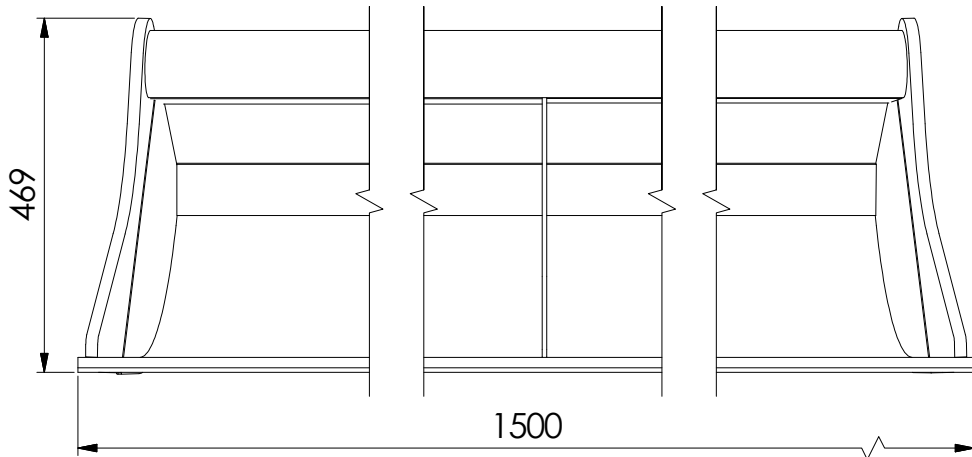

B

B



A

A

MATERIAL SPECIFICATION	
	ST52.3
	EN8D
	HB 400
	HB 450
	CASTALLOY STEEL

SCANBOLT®	
DESCRIPTION	150CM CLEANING BUCKET
MACHINE CLASS	7.5 TON
WEIGHT	214.5 Kg
HEAPED CAPACITY	328.3 LITERS

8 7 6 5 4 3 2 1